

# CATS

CAPITAL AREA TIMEX/SINCLAIR  
USERS GROUP

# NEWSLETTER

\$1.00 per copy  
Please support your computer  
JOIN C.A.T.S.!

Volume 5, Number 7

November, 1987

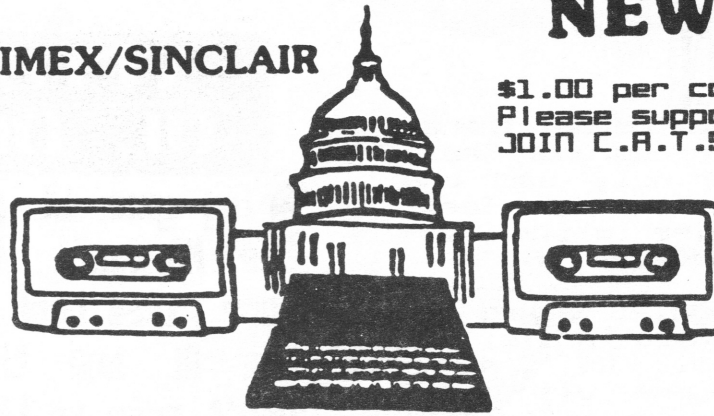

## IN THIS ISSUE

Potpouri.....	3
QL on the QT.....	4
Why Sinclair?.....	5
QL to Monitor. Come In!.....	6
Printing on QL with SG10.....	7
Computerfest Videotape List.....	7
3-D Wire Frame Graphics.....	8
Are Floppies A Dying Breed?.....	9
Program Writing from Top Down...9	
Reset Switch for 2X81 and 2068..10	
2068 Power Supply Project.....	11

## CONTRIBUTORS

Tom Gent	Hank Dickson
Vernon Smith	Tim Swenson
George Rey	Wendy Rohm
Mark Fisher	J. W. Dowell
Akin Olawofoyeku	

## PRESIDENTIAL RAMBLINGS

This month, now that many of us have had a chance to digest so much of the new computers, disk drives and capabilities, we should now start focusing on applications. We have had requests to have language programming classes or rather brainstorming sessions to tackle programming problems (both 2068 and QL). Duane Parker is interested in applying the Forth Language to his problems. Anyone interested should contact him either at home or at the next meeting.

The power of the QL also brings to mind other tutorial applications. We are looking for a consensus as to creating other classes for programming database or spreadsheet applications (for both machines) for instance. These can be held before the general meeting or at other convenient times or places, provided the class is small.

## DISK DRIVES ANYONE?

Anyone interested in acquiring 3 1/2" disk drives, please let us know. We can get a good deal on them @ \$95 if there is enough interest.

Here is what's coming up among other things. At this meeting, Mark Fisher will give a long awaited tutorial on the use of Archive and programming in the Archive resident programming language.

Mark Stueber of Sharp's, has informed me of the Z-88's arrival, Sinclair's new laptop computer. He said that he could make the December meeting and demo this machine. The present price is \$399.

Tom

## FROM THE EDITOR

Come on! I know you're out there. The newsletter needs your help and, believe it or not, each one of you can. What I need is feedback and, from time to time, answers to various questions.

Several issues ago, I asked for help from a graphics artist but no one volunteered. Well, maybe we don't have anyone with that talent, but this time it's different. I need to know what you think about the type faces in the newsletter. This column is being written with a font called NINE-TY. I selected it because, in the 2,0 size which is 10 cpi (Pica), it didn't have that "dotty" look like so many computer typefaces. Several people have indicated that it was difficult to read. On page 4, the QL on the QT column is printed in STANDARD. Which one do you like? We are using the fonts available from Digital Precision's Desktop Publisher which has 21 typefaces but very few that are appropriate for a newsletter. As I've said before, this is your newsletter so let me know what you want.

This issue kicks off a Letters to the Editor column. Having trouble with a supplier? Got a gripe? Need a question answered? Let me know. I'll publish your letter. Also in this issue, we start a series of interest to every QL owner, both new and old, on various hardware fixes needed to protect your computer from all the nasties on the outside. Mark Fisher, one of the most prolific writers in the QL world, will write this feature with additional technical assistance from Tom Bent. These modifications have been tested by Mark, so you can be sure that they work. It has been pointed out that some people aren't getting information about the group buys. On page 3, you will find a list of group buy items and the member that is coordinating the purchase. We will update the listing monthly. Finally, we continue our focus series with additional articles on the 2068.



## ATTENTION QL OWNERS

Bring your QL power supplies to the Hardware Workshop. Tom has some fixes that will protect both the QL and the power supply. Don't pass up this opportunity to make your QL more reliable.

### NOVEMBER MEETING AGENDA

11:00 Hardware Workshop

**Installation of QL Power  
Supply protective devices**

2:00 General Meeting

4:45 Adjourn

Presentation: **QL Archive by Mark Fisher**  
Rescheduled from the October meeting

### NEWSLETTER SUBMISSIONS

Submissions for the newsletter can be in hard copy, with columns 35 characters wide, or, preferably, magnetic media. For the QL, microdrive cartridge, 5 1/4" DS/DD or Quad density disks, or 3 1/2" disks. For the 2X81, TS1000, or 2068, cassettes only, with titles on the box.

Send material to:  
Editor, CATS Newsletter  
Box 467  
Fairfax Station, VA 22039

# POT POURRI

News Around the Beltway

## GROUP BUYS

### YOUR DUES AT WORK

This is a list of the group buys in which Group members may participate. As more information becomes available, it will be published in this column. If you have specific questions, talk to the coordinator.

Item	Coordinator/Phone
3" Drives	Bob Warner:345-3816
3 1/2" Drives	Tom Bent:{301}730-7187
Larken IF	Vernon Smith:978-1835
RGB Monitors	Phil Russo:441-1946
GLS	Tom Bent: See above

If you think of other items and would be willing to coordinate the buy, let one of the Executive Committee know.

## MAILING LABEL CHECK

When does your newsletter subscription (and CATS membership) run out? Look in the upper right hand corner of your mailing label. If the "last issue" date doesn't agree with your records, let Ruth know.

### Letters to the Editor

I am an \$18.00 member; if anyone figures out how to order Timex Portugal disk drives, I am interested in buying a back up system. After all, Mark Fisher has done business before; maybe you all are the only ones capable of pulling off that enterprise. That is, if you are listing interests in buying, put my name on that list.

Joan Kealy,  
El Paso, TX

Joan,  
Your best bet for a back-up system is NOT a Timex of Portugal disk drive system. Timex is closing down their Portuguese operations and even Mark Fisher's expertise is insufficient to change their minds. The system uses 3" disks

which cost \$4 EACH!

Additionally, this system is not compatible with the American 2068. Why not consider a Larken, Oliger, or Aerco IF and then use some 5 1/4" drives? This will insure future support and disks are only 25 cents each.

If you have a question, a gripe, or want to pass along some information, send it to the Editor. I guarantee that your letter will be printed.

## NEW PRODUCTS

### A digest of press releases

AFB Software has introduced four programs for the ZX-81 and TS2068. ZX-TEXT and T/S-TEXT 2000 are word processors, ZX-CALC and T/S-CALC 2000 for spread sheets, T/S-ZX FINANCIAL REPORT GENERATOR for cycle accounting, and ZX-CALENDAR and T/S-CALENDAR 2000 is an appointment scheduler. AFB Software, 1605 Pennsylvania Ave., #204, Miami Beach, FL 33139

TIMEX REPAIRS ARE BEING MADE BY DAN ELLIOTT, Rt 1, Box 117, CABOOL, MO 65689. CHARGES ARE \$15 PER ITEM, PLUS PARTS, WITH AN ADDITIONAL \$5 IF IT IS MODIFIED.

Gray and Clifford have announced 3 new telecommunications programs. SPECTERM-64 (TS-4.1) is on disk for the JLO SAFE and AERCO FD-68, TMX-64 is 300/1200 baud bulletin board software for the 2068, and ZX-TERM\*80 is TS1000/1500 terminal software. Box 2186, Inglewood, CA 90305.

Matthew Zenkar is offering a 512K RAM expansion board for \$130. After installation, the Expansion Port cover can be reinstalled. We will try to arrange a test of this board to obtain benchmarks. PO Box 12534, Rochester, NY 14612

For additional information about the items mentioned above, see the newsletter and/or product binders which are at each meeting

# QL on the QT

by Vernon Smith

This month lets talk about the future of the QL. To do this adequately, we must address the question from both a global and a local point of view.

The overall destiny of the QL is controlled by Amstrad and that doesn't bode well for the QL. Amstrad has made a lot of money flogging old technology like CP/M and MS-DOS and, from where I sit, doesn't seem to care much for advanced computers, like the QL. The underground rumbles with rumors that the QL will be resurrected this Spring with a built in disk drive. They scrapped the QL but now they may turn to it as their savior. How ironic. The big question is what size are the drives? Rumor has it that they have bought most of the 3" disks, so they might bring out a machine which uses them. The latest ZX Spectrum +3 just released by Amstrad does just that. If they do, rather than use a 3 1/2" drive, they can kiss off the US market at least. The 3" drive is a loser. No one makes the disks and the existing ones are too expensive. Yet I wouldn't be surprised if the follow-on QL (if such a beast appears) will utilize the smaller disk. If you look at it, Amstrad's purchase of Sinclair was a defensive measure to remove competition from their machines. Not a bad idea, if you can continue to sell your product. We are, however, talking hi-tech, not laundry detergent. The product life cycle is short and the consumer is more technologically sophisticated. The buyer is now demanding machines which combine value with technology. Amstrad isn't known for their technological innovation but rather for their marketing ability. I have a feeling that they are a little short in this department as well. They made money when everybody (except Uncle Clive) was making money, but lately they've not had much success selling their long-in-the-tooth machines. Their IBM compatible, the PC 1512, was a bomb and their PC 1640 seems to be a 1512 with a mouse and "windowing software for state-of-the-

art desktop publishing". Their latest product is a laptop computer "that will allow American executives to do something existing products have not allowed them to do before". Folks, I'm not making this up, these are quotes from Amstrad's own ads.

Locally, the outlook is a little brighter. With Mark Steuber pushing QLs out the door for \$99, the installed base should grow. Very little software is being developed in the US but the UK and German software houses are marketing some excellent software. QUANTA is an excellent source for nearly free software. The only area where the US seems to be holding its own is the development of hardware extensions. One of the most prolific designers is none other than CATS' own Tom Bent. Tom designed the clock battery backup pictured in QL World (Nov 87, p.14, upper left) and an EPROM board. Currently he is working on a buffer for the ZX 8301 chip and adapting 10/20MB hard drives to the QL.

Now a word of advice. Be careful with whom you do business as some of the dealers don't stock the hardware and software they advertise. When they get an order, they turn around and order it from the distributor. So when you find a vendor that treats you well, stick with with him. If you find one that doesn't, write to the editor of your newsletter and ask that your letter be published. I believe that all newsletters ought to provide such a service. I was stiffed for big bucks by Ramex/Foundation Systems. Later I found that others had too, but no group's newsletter raised a warning. Since most groups exchange newsletters, if such information was published, it would be quickly disseminated throughout the US. We need an early warning system that helps our members keep from being ripped off.

Finally, send me your nominations for the Software Program of the Year. In January, I'd like to recognize the program that you feel was the best to be released in 1987.

## WHY SINCLAIR ? by GEORGE REY

The GOOD (Fantasy) -- As a boy (~1940) I was a science fiction buff who had read all that had been written on the subject. One story in Famous Fantastic magazine titled "Donivan's Brain" exposed me to computers. As I recall, Donivan was a computer buff who broke the artificial intelligence barrier and made his brain (computer) capable of thinking -- for itself. As the brain developed to adulthood it realized -- "Its them (people) or us (machines)". To survive it set out to have robots reproduce its kind while purging the human race. The extinction of humans is not possible (?) now as we have federal protection to prevent such hazardous technology to be developed. When I trained in Naval Warfare my ROM was programmed to the need for computer Fire Control (shooting) as it had been proven to be superior to prior means. With national defense as a major USA priority, its no wonder then that all them then Baby Blues (chips?) would be fed (subsidized) to maturity (and then some). So, who said there ain't no such thing as a free lunch?

The BAD (Reality) -- I went on to make a living in the High-Sci field where I worked at producing facts within budgets. Meanwhile Boy Blue chips infiltrated my work world and challenged me to look-see-at and how-to-use computers to solve problems. In my first course to see-how I was fed the fact (propaganda ?) that computers were as fast as electrons. At course end I posed a typical problem and asked how fast, in total time, I could get an answer. The instructor said "Three minutes after you start running the program -- but, it takes three months to develop a program for it". With my time for like problems at three weeks, I could not afford to pursue feeding the Boy Blue world and my family at the same time. Latter, on a well endowed (money to burn) project I had to accept a computer to burn up the excess. And it did, but with nice print outs of past data -- but never an answer. I was then assigned a computer buff to solve our problems. I gave him one to do, one I had already solved and had verified in the literature. Well, his brain said "It can't be done". When I showed him that it had been done he bucked me with a true Blue claim "The computer is the greatest innovation in history". So I gave him another one -- how to get to and from work every day. He solved it -- the answer was use an ICE (Internal Combustion Engine) machine.

The UGLY (Buffalo Chips) -- When I read about the micro chip I surmized that soon a PC might become a reality for small businesses and the home -- if the price was right. I started to bone-up on computers, as I felt I may be able to find something useful for them to do. I engaged the literature (mostly buffalo chips) and a computer buff colleague of mine to identify the pitfalls ahead. I concluded that I had to keep from being nickled and dined into poverty and malnourished (fed) with chips (BS), be they blue or of buffalo origin. Then along came Sinclair with the TS-1000, a mini Ford for people that think they need a computer. I did not buy it as it was not what I wanted as a final system. Then he offered the TS-2068 which was close to what I wanted, so when its price fell to \$200 for a complete system with programs, I could'nt refuse. I got one knowing it was the best one to learn basic programming, should I have to do so, so as not to get dined to death by software (pirates). Shortly thereafter Sinclair set off a time bomb (Computer & Electronics - April 1984) with the introduction of the QL to sell for \$500 with the four programs I felt would be all I'd ever need. So when the price dropped to \$120 I could not refuse. Now, the QL, I believe will be all I will need for a long time to come.

To sum up, Sinclair gave us the prices and inovations needed to break up the monopolies of the now Big Blues. He gave us Model-T's at good prices and his models are not likley to be outclassed by the blue chips any time soon as the chips can't compete in pasture where there is no free green grass.

# QL to Monitor... Come In! Buffering the QL

By Mark Fisher

Why buffer?

A large number of CATS members have taken up Skip Fisher on his offer of reconditioned RGB monitors for \$70.00. Those that have seen them know that these are tanks of the monitor world - they are built to a standard of ruggedness that was last seen in the Kaypro 4. That ruggedness doesn't extend to the electrical connections, however.

While the QL can put out signals to drive standard TV's, composite monitors, PAL monitors (I think), or RGB monitors, only the RGB outputs are unbuffered. This means that the actual wires that connect the circuit boards of the monitor and the QL are solid copper ribbons, without a semi-conductor device to isolate and clean up the signals that pass over them.

So what? Well, try just plugging your monitor in sometime. You'll hear an ominous hissing and crackling; that's normal - it's just the 6000 volts of the electron beam gun unlimbering itself. If just a little of that static gets into the signal lines... Poof! an ex-QL.

One other point, for those optimists among you. These monitors are very sensitive to stray background noise on the lines. This translates to messy retrace "garbage" on the screen. An input buffer for the monitor cleans up the signal, leaving only a clean, sharp image that would make an IBM monitor weep.

## How to build it

The actual circuitry for this marvel is almost trivial (but trivial in the sense that a fuse in your house is trivial). The circuit consists of two chips: an 74\_LS\_244 to buffer the Red, Green, Blue, and Vert Synch lines, and a 74\_LS\_04 to buffer and invert the Horizontal Synch. (Research on alternates is continuing, and if it's possible to do it with one chip we'll let you know.) You will also need a .1 mf disk capacitor, and if you want to be able to "change the fuses" you'll want a 20 and a 14 pin socket.

The pin numbers on the monitor socket refer to the Mitsubishi C-3240 LP monitor. If you've got a different monitor you'll have to figure out that end for yourself. The wire colors mentioned refer to the colors in the RGB cable supplied by/with/for the QL. (Two minor QLbbles - why couldn't Sinclair have specified Red, Green, and Blue for the R, G, and B lines from the QL? And why is the line that should be purple actually black? [it's not the ground, of course.] Oh well.) Strip the cable cover back a few inches, and snip off a two-inch length of the various colors for the chip-to-plug run.

After you've got it soldered up, insert the chips in the sockets, and test it. Bad connections are pretty obvious - if one of the colors is missing, that's the line you fouled up. Assuming that everything works, carefully tape the pair to the end of the cable.

Have fun soldering, and I'll see you on a clean screen!

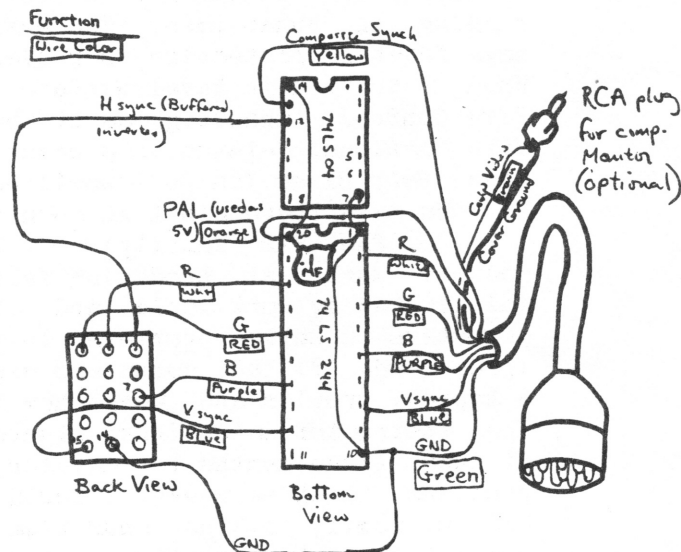

## Law Enforcement In The Chips

Paul Dye may spend a lot of time waxing poetic about what a double-edged sword computers can be. Dye is a convicted British smuggler who kept track of his important meetings with his trusty Psion Organiser hand-held computer—a man who smuggles \$150 million worth of heroin through Heathrow Airport probably has a lot of appointments to keep.

When authorities caught up with Dye they found no contraband, but they did find his computer. Dye was nonchalant—he had erased everything, or so he thought. Turns out the Psion stores information not only in RAM but on an EEPROM chip as well, just in case the owner inadvertently erases something. The authorities took the EEPROM cartridge to Psion, where software technicians had little trouble extracting the data that led to Dye's 28-year sentence.

Moral: Always read the owner's manual.

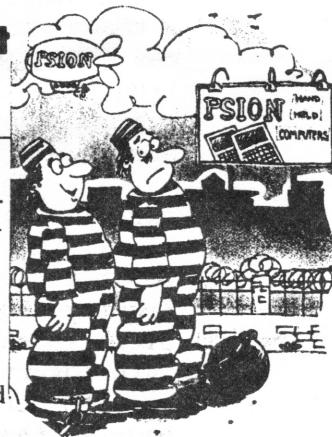

From InformationWEEK--September 28, 1987

Printing with Star SG10 on the QL

Having just acquired a QL, an RGB monitor and a centronic IF, I was so excited that I decided to put my QL to use immediately. My first attempts to print both my documents and spreadsheets in fonts other than Bold, Pica, Highscript, or Lowscript were met with frustration.

Thanks to Mark Fisher, who quickly came to my rescue. After about 2 hours, we finally figured the problem out. We had to create tokens which were imbeded in the documents, or in the cells of the spreadsheets ahead of what you would like to print. These tokens were created and accessed with CTRL and keys at the top row (1 thru 9).

The following is the printer driver as installed with F5 in the Abacus and the Quill, using the SG10 printer.

	Comments
DRIVER NAME	:STAR SG10
PORT	:Ser1
BAUD RATE	:9600
PARITY	:NONE
LINES/PAGE	:58
CHRS/LINE	:80
CONT. FORMS	:NO
END OF LINE CODE	:CR,LF
PREAMBLE CODE	:ESC,"B,2 Elite on
POSTAMBLE	:NONE
BOLD ON	:ESC,E
BOLD OFF	:ESC,F
UNDERLINE ON	:ESC,-,1
UNDERLINE OFF	:ESC,-,0
SUBSCRIPT ON	:ESC,S,1
SUBSCRIPT OFF	:ESC,T (c1=CTRL)
SUPERSCRIP ON	:ESC,S,0
SUPERSCRIP OFF	:ESC,T
TRANSLATE 1	:"c1,esc,"B,4 NLQ on
2	:"c2,esc,"B,5 NLQ off
3	:"c3,esc,"W,"1 Expd on
4	:"c4,esc,"W,"0 Expd off
5	:"c5,esc,"p,"1 Prop on
6	:"c6,esc,"p,"0 Prop off
7	:"c7,esc,"G Dbl Sk on
8	:"c8,esc,"H Dbl Sk off
9	:"c9,esc,"B,3 Conds on
0	:"c0,esc,"B,1 Pica on

VIDEOTAPES OF TECHNICAL SESSIONS  
AT THE 1987 COMPUTER-FEST  
By Topic and Speaker

Machine Code for the ZX81, Basil  
Wentworth

Desk Top Publishing, Mark Fendrick

The FORTH Language, Gary Ganger

Graphics on the TS2068/Spectrum,  
Dave Franson

Hardware Interfacing, Tom Bent

Printer Interfaces, Dick Cultice,  
Dave Franson, Bill Heberlein

The QL and Superior Sinclair Tech,  
Frank Toemay

COMPUSERVE, Pat Spera

Cottage Industry and the Computer,  
Tom Woods

Roundtable Discussion of T/S Tele-  
Communications, Kurt Casby, Pete  
Fischer, Ed Gray, Gary Lessen-  
bury, Pat Spera.

NOTE: George Rey, CATS vice-  
president, may recommend  
building some future  
meetings around selective  
viewing of some of these  
tapes.

**TAPE LIBRARY INFORMATION**

The C.A.T.S. tape library is  
available to all full {\$18}  
members. Prices, per cassette,  
are \$3.00 by mail or \$1.00 at  
the meeting.

Mail order requests, and  
submissions for publication,  
should be sent to the tape  
librarian:

Rev. John Riley  
120 N. Fairlawn Dr.  
Carrollton, GA 30117

Checks or money orders should be  
made out to C.A.T.S.

We will continue to  
"compensate" contributors with  
one free cassette from the  
library.

# 3D WIRE FRAME GRAPHICS

by Tin Svensson

From Tinelinez, September, 1987

The program listed below allows a person to define a 3-D object, draw it on the screen, and rotate it in three different planes.

The heart of the program lies in how the object is represented. Two arrays hold the information for the object. A vertex array (list) holds all of the vertices. An edge array (list) holds the two endpoints of the edges. The edgel array refers back to the vertex list for the actual points. It only holds the number of the vertex.

Lines 100 to 1030 in the program holds the definition of a cube and some values for variables used by the program. Look at the diagrams and the two lists to see how the cube is defined. More complex figures will take more information.

The center of the cube is (0,0,0). This can be changed by the user. The variables XX, YY, and ZZ define the center that the user chooses.

There are four procedures in the program. They are treated as keywords. To display the object the user can type in directly, or in a program, DISPLAY3D. ROTX, ROTY, and ROTZ rotate the object in radians held by the variable ROT. The program says that ROT is 20, its wrong. It should be in radians, like  $\text{PI}/10$ . Just to refresh your memory  $\text{PI}/2$  is 90 degrees.

When a rotation procedure is called the object is spun in the axis defined. Since the Z axis is pointing out of the screen, rotating the object will make it appear to spin like it is on a turntable and you are looking down on it. I hope this is clear.

The variable D2 changes how

large the object is on the screen. The larger the number the smaller the object.

When you run the program as it is, nothing appears to happen. All it has done is to load the array with the data and set up the variables. Type ROTX, ROTY, and then DISPLAY3D. You will now see the cube at an angle.

Have fun with the program. If you have any questions feel free to contact me. Its hard to summarize a lot of material in a short article.

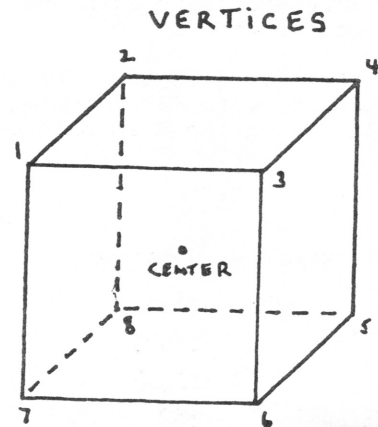

VERTEX LIST

1= (-1,-1,1)	2= (-1,1,1)
3= (1,-1,1)	4= (1,1,1)
5= (1,1,-1)	6= (1,-1,-1)
7= (-1,-1,-1)	8= (-1,1,-1)

EDGES

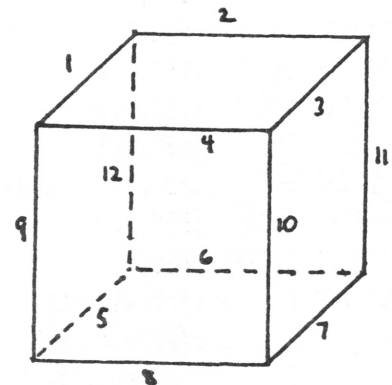

EDGE LIST

1= (1,2)	2= (2,4)
3= (4,3)	4= (3,1)
5= (7,8)	6= (8,5)
7= (5,6)	8= (6,7)
9= (7,1)	10= (6,3)
11= (5,4)	12= (8,2)

To be concluded in the next issue,



## ARE FLOPPIES A DYING BREED?

by Wendy Goldman Rohm

from INFOSYSTEMS, 7/87

Evolution is as unrelenting in the computer industry as in nature. Computer technology's timetable is ruthless, however. Instead of changing over the course of centuries, the industry moves at breakneck speed. Machines once on the leading edge of technology are often supplanted by the next generation before they have fulfilled their promise. The latest adaption confronting the microcomputer species is the 3 1/2" diskette drive. This "mutation" promises to become a standard part of the micro anatomy.

With the huge number of 5 1/4" diskettes already in use (more than three billion according to industry experts), there will probably be some resistance to this new format. Nevertheless, 3 1/2" microfloppy disks are predicted to become the dominant storage medium by as early as 1990. IBM's April announcement of its 3 1/2" based Personal System/2 only accelerates an evolution that many see as inevitable.

"The old standard has to give way in favor of the 3 1/2" disk, which has more capacity and is more convenient and reliable," says James H. Porter, president of Disk/Trend, a Los Altos, CA-based research firm specializing in the disk-drive industry. "It's all downhill for 5 1/4" floppy disks now, and all uphill for 3 1/2"."

Phil Devin, senior industry analyst at Dataquest, San Jose, CA, agrees. "The 5 1/4" floppy disk-drive market is, in fact, peaking this year. By 1990, 3 1/2" sales will definitely top 5 1/4",...

Unquestionable benefits. What's the rucus all about? The 3 1/2" diskette, as well as the 3 1/2" diskette drive, were originally pioneered by Sony about five years ago. Their development was fueled by the recognition that the 5 1/4" floppy was rather bulky relative to the amount of information it stored, as well as susceptible to damage.

...In addition to economizing on space, the 3 1/2" diskette abandons the "floppy" quality of its 5 1/4" predecessor for a hard shell. An envelope is not necessary to protect it from the perils of a busy office environment. By putting it in a hard shell, we've solved the fingerprint issue and prevented exposure to smoke, dirt, dust, and so on." The new format also reduces power requirements. The power needed to run the 3 1/2" drive is about one-third that is needed for a 5 1/4" drive.

Data storage capacity is another plus. The typical 5 1/4" floppy disk stores about 360K (395K in ours) bytes of data; the 3 1/2" versions are

available with either one or two megabytes and 1.44 M bytes remaining for storing data.

From The Data Expansion, 1/SUB of Ft. Worth, September, 1987

The 5 1/4" drives referred to are DS/DD rather than the Quad Density (720K) drives most CATS members have. The 3 1/2" drives in the Group Buy column are also 720K drives. Tom is looking into a group buy of 3 1/2" (1.44 MB) drives.--Ed.

### REMINDER

If you are interested in a PROGRAMMING WORKSHOP,  
let Tom, Duane Parker, or me know.

### PROGRAM WRITING FROM THE TOP DOWN

The last time I wrote a program, which was quite a while ago, I had to go back into it and re-do and re-do. That was not just the debugging, but trying to get the program to print the things that I wanted and in the correct place. I could have used this book:

MICRO COMPUTER SOFTWARE DESIGN  
HOW TO DEVELOP COMPLEX APPLICATION PROGRAMS  
BY SALLY CAMPBELL

How many of you could have been "educated" by this same book?

I learned about defining my problem completely and coming up with a functional design for the program. That does not mean that I learned how to "flow-chart", but how to come up with a modular design that would accomplish what I wanted done. This may not seem like it is anything very special, but it is. With the program in modular design, it is very easy to change the program and know where the problems are when you begin to debug it. If you wish to add more in later, you could actually write the module over again-outside of the program itself-then change (or MERGE) it back into the original program knowing that everything else would still work the way it originally did.

If you are still having problems using the correct procedures, the author tells you how to translate words from English into a pseudocode that is relatively easy to understand and actually translate the pseudocode into actual BASIC commands. Once that is complete, it is relatively easy to work out the DATA definitions and the file access methods.

Sounds like a lot from just a book, doesn't it? Well it is, but this book does exactly that and very clearly as well. I think that, with a fast look through this book, you could work out almost any type of program that you wanted to write. It has greatly enhanced my capabilities to see how to write better and easier read code for those that want any of my programs to use. Check it out, you might be surprised.

From The Data Expansion, 1/SUB of Ft. Worth, September, 1987

CATS 9 NOVEMBER

# focus on:

## TIMEXsinclair

### 2068

Selected articles from other  
users groups' newsletters

## Hardware Project: A Reset Switch for ZX81 and 2068 Computers

From DTSA, Dallas TSUG, September, 1987

#### ----- PARTS REQUIRED:

1: A Very Small SPST Momentary-Contact Switch -- Normally Open.  
Preferably Pushbutton type.

Radio Shack has two:

275-1547 1/4" Mounting Hole, sold in packs of five/2.49

275-1571 3/8" Mounting Hole, sold in packs of two/ 1.69

2: About a foot or so of speaker wire or light-gauge stranded wire, or wire-wrap wire. My guess is that you can find some of this without having to buy any, but Radio Shack has some really small zip-cord (278-1301) if you need it.

3: Very light-duty rosin-core solder (RS 64-005)

4: The Computer. Only the main CPU unit is necessary.

5: Tools to Use: Soldering iron, medium-size philips screwdriver (for case disassembly), small hand drill or small bit power drill or hole reamer the size of the switch mount. An Exacto knife is also helpful.

#### Why a Reset Switch?

-----  
Every computer occasionally gets hold of bad data or instructions. This can occur during programming, loading programs, or when the peripheral bus or power supply is disturbed in some way. This tends to derail the normal progress of the CPU, and a crash or at least aberrant behavior occurs. On Timex and Sinclair computers, restoration of normal activity is achieved by shutting off power to the unit: the 2068 has a power switch, but the ZX81 and TS1000 have no switch and must be disconnected from the wall supply at the power jack (left side of the computer). Nothing is wrong with solving a crash this way, but even when it is convenient, it is a stress on power components (including the snap switch on the 2068). The peripheral bus on the back of your computer, however, contains virtually all the CPU's signaling connections, and that includes one pin on the Z80 called RESET.

RESET only needs to be connected to ground for a split-second for it to guide the Z80 back to its first address point and start it executing its beginning instructions, just as if you had turned the machine on. This clears all memory-- more useful than you'd think! Reset causes no stress or spikes in its operation. It was meant to be grounded until the CPU needs to come on. Most computers already have a reset switch; Sinclair saved several cents per computer by omitting extra hardware. Our task is simply to connect one wire to the RESET line and one wire to ground, linking them to a small pushbutton you can reach (but not press accidentally), to connect the two wires momentarily. You will need to mount the pushbutton on your case where you wish, making sure that peripheral equipment won't be in a position to shove it.

#### ----- INSTRUCTIONS FOR RESET SWITCH

1. Undo the screws that hold together the case of your computer. Three screws on the ZX81 are under rubber feet, so carefully peel off the front two feet and the one just behind the expansion port. Two other screw holes on the bottom are not covered, there are five screws in all. The screws are pretty tight, so use the proper screwdriver.

The 2068 case has seven very accessible screws on the bottom, but note that they are not all the same size, so when you lay the screws aside, put them in order on the table.

2. You can remove the bottom of the ZX81 case now. Turn a 2068 right-side-up, then carefully separate the halves by a couple of inches at the front. You will see a white ribbon connector that goes from the keyboard to the main board. Firmly lift the ribbon off the main board: it is just stuffed into the black slot at the back of the board. You will just stuff it back in when you put the case back together. Remove the top of the 2068 case.

3. Look around. Decide where your switch will go. The 2068 has a good spot behind the right joystick connector, to be installed sticking out of the right side of the case bottom (other places are O.K., too.) Remember to look at the clearances you will have when the case top is replaced.

The ZX81 places are generally on the case top, meaning you have to remove two screws, both next to the grounding strap, to lift the main board up. This particular ribbon connector is extremely fragile, especially with age, so be careful when you are moving the board. The ZX81 keyboard ribbon pulls out of the two connector slots on the main board. ZX81's right side has lots of room...

4. After you've positively identified where you want your switch, you need to drill the hole. Remove any burrs or flakes of plastic that might impair the seating of the switch.
  5. Solder a length of wire to each ear of the switch. Then install the switch tightly to the case.
  6. Locate on your machine's main board, the pins on the expansion port for ground and RESET. The ZIB1 RESET trace is on the component side of the board, but is accessible through a hole on the non-component side. If you look at the edge connector on the non-component side, there is a hole wedged between fingers two and three, counting from board's edge. That tiny hole is the reset line. If you solder from component side, it is finger three. The ground finger is easy to find: it is the doubly-wide finger near the slot on the non-component side. The 2068 RESET finger is the ninth from the edge, and the ground is the first from the edge, both on the component side.
  7. Trim wires to length, tin the ends with solder, and solder them to the appropriate spots. It does not matter which wire goes to which pin.
  8. Reinstall the keyboard ribbon and the other side of the case. Put the screws back in, and you've finished.
- One last thing is the ZIB1 rubber feet. If they do not stick back on, double-sided tape or contact cement will reinstall them.
- Try out your new switch. Fun, eh?

## 2068 POWER SUPPLY MAKE IT COOLER & QUIETER

By J. A. Dowell

Reprinted from 2K Appeal, June 1987  
Originally published in S&A, January, 1986

I have discovered that programs SAVED to cassette tapes from the TS-2068 can have a very high Noise/Scratch background level making verification and loading a somewhat iffy proposition. The best way to determine if you have this problem is to monitor the signal on the tape aurally during loading. The background noise can be heard before the leader and between the leader and the program. If this condition creates a problem for you, the following will provide a solution.

The TS-2068, when operated from a DC supply voltage of more than 13 volts, creates a superfluous noise on the internal power distribution lines, probably from the action of the switching voltage regulator which supplies the regulated 5 volt supply. Somehow, this noise finds its way to the SPKR/TAPE output of the SCLD chip. For some unknown reason, if the DC supply voltage is reduced to something less than 13 volts this noise disappears. I have found that a supply voltage of about 8 volts gives very good results. There are two drawbacks: At less than 15 volts you get NO COLOR output and the A&J MicroDrive will not work.

Because I sometimes wish to use the MicroDrive and the Cassette tape storage interchangeably, as in taking programs from the MicroDrive and giving them long term storage on the cheaper cassettes, I developed a voltage reducer to put in the cord of the TS-2068 power unit so that I can change the supply voltage from the normally used 15 volts to a lower 8 volts when I want to save a program to cassette tape. The supply voltage can be changed from 15 volts to 8 volts and back to 15 volts without affecting any of the program or data stored in the TS-2068 memory.

Also, by operating the TS-2068 at a normal 15-16 volt level rather than the power unit's output of about 21 volts, the heat dissipation in the TS-2068 is reduced considerably.

The schematic of the voltage reducer is self-explanatory. Two words of caution, however. Although the regulating transistor, 2N3055 or similar, is capable of passing many amps of current, it must be well heat-sinked as it dissipates about 5 Watts when delivering the low voltage output. When cutting the cord of the power unit, verify the polarity of the leads when they are reconnected remembering that the outer contact of the concentric connector is positive and the inner contact is negative.

-- J W Dowell

CKT TS/2068 Voltage Reducer

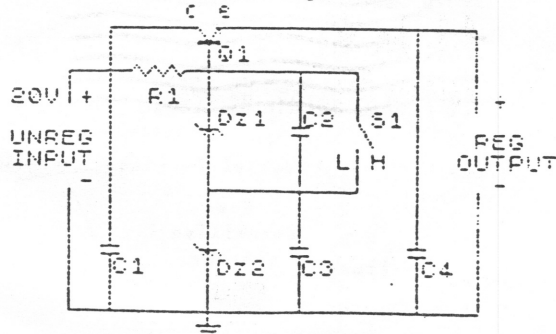

- |                |                 |
|----------------|-----------------|
| C1 - 0.1mf Cer | R1 - 270 ohm/2W |
| C2 - 100mf/10V | Dz1 - 6.4V/.4W  |
| C3 - 100mf/10V | Dz2 - 9.1/.4W   |
| C4 - 0.1mf Cer | Q1 - 2N3055 ETC |

### FOR SALE

T/S 2040 printer...\$20  
T/S 1000 computer...10  
16K rompack.....7  
Software...30 titles..3  
Prices plus postage

Contact the Editor

CRIS maintains a gratis exchange of newsletters with approximately 30 Users groups across the U.S. Clubs not sending a n/l to us for six months are automatically taken off the list.

02X 08S: {505} 522-7081 F100 net 15, node 6, East Coast dial {703} 547-4815 F100 net 18, node 9.

TimeX SIG on CompuServe: Wednes- day night, 10 P.M. Eastern time {60 CLUB}.

**Networks**

Memberships cost \$18 per year, are good for 12 months, and in- clude all privileges (access to libraries, group buys, etc.). A newsletter subscription only is available for \$12 per year.

**Newsletter**

Monthly meetings are held from 11 AM to 5 PM, on the second Sat- ursday of each month, at the New Carrollton Public Library.

**Meetings**

- President Tom Bent
- 1st Vice President Hank Dickson
- 2nd Vice President George Rey
- Secretary Mike Wurmick
- Treasurer Ruth Feyley
- Members at Large Mark Fisher
- Bill Barnhart
- Bob Currnut
- Vernon Smith
- Editor & contact person Vernon Smith

**Executive Board**

is a not-for-profit group devoted to serving the interests of those who own, use, or are interested in the TimeX/Sinclair family of computers.

**Users Group**

The Capital Area TimeX Sinclair

CRIS Newsletter  
P.O. Box 467  
Fairfax Station, VA 22039

**FIRST CLASS MAIL** USA 22

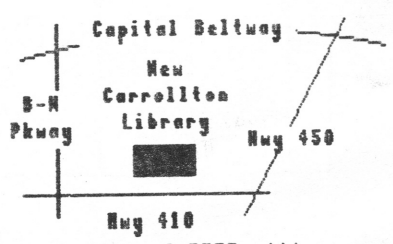

The next meeting of CRIS will be held on:  
Saturday, November 14, 1987 11:00 AM Hardware Meeting  
2:00 PM General Meeting

At: New Carrollton Public Library  
7414 Riverdale Road (Hwy 410), New Carrollton, MD

IF YOU ARE NOT A MEMBER OF CRIS, THIS IS THE ONLY ISSUE YOU WILL RECEIVE

DUES: \$18 per year, per family